

Robust Functionality

Load Break Switch Typ FWA
e.g. to insert power
consumed distribution

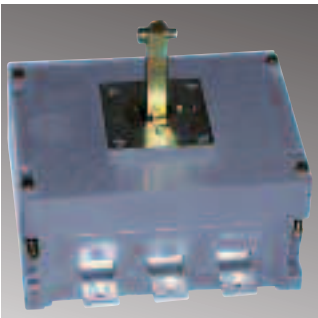

Load Changeover Switch Typ FMU
with visible disconnection

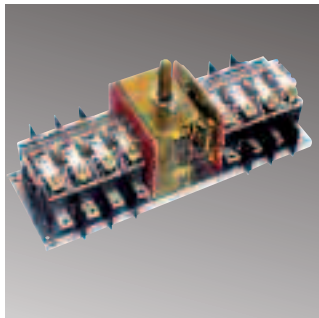

Load Break Switch Typ FAM
with double disconnection

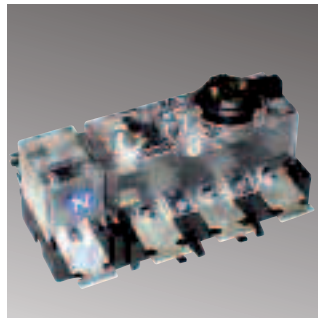

Visible disconnection
Load Changeover Switches FMU
Bypass Switches FMU BY 1

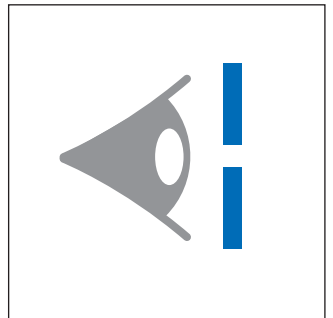

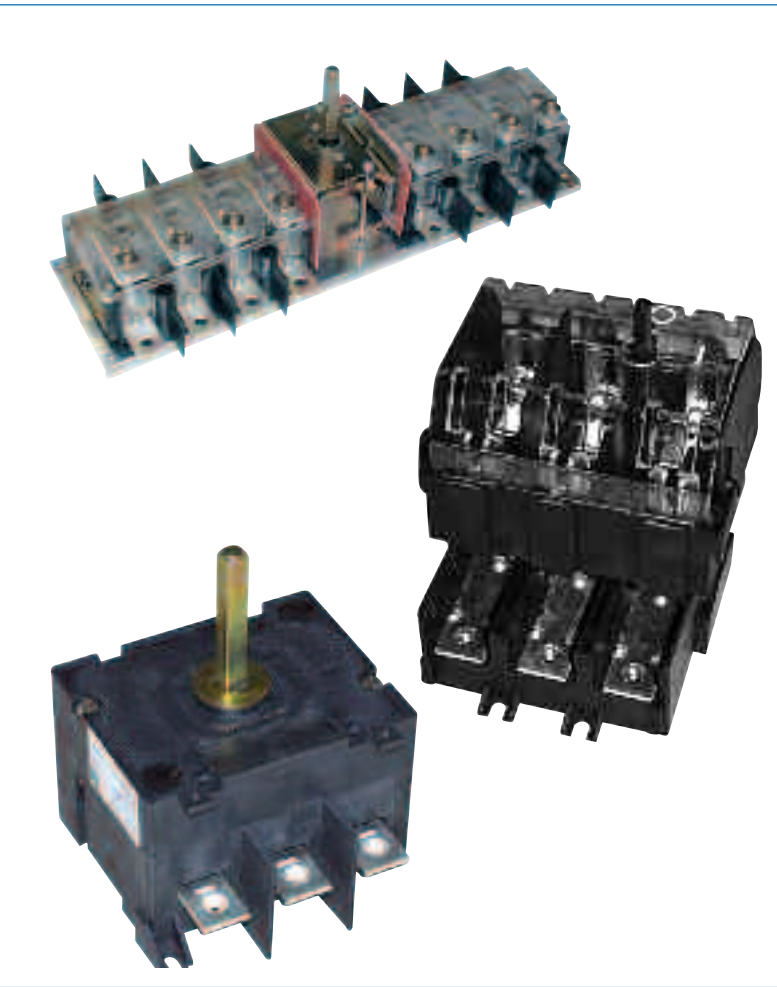

Content

Load Break Switches	76
Switch Fuses DIN and BS	79
Load Changeover Switches 1 - 0 - 2	81
Main Switches	85
Bypass Switches 1 - 0 - 2	86
Technical data	see page 88

System

The EFEN Load Break Switches / Changeover Switches are sturdy and versatile devices. 3- and 4-pole versions are available in the portfolio as well as bypass versions with dual switch mechanisms, i.e. 6- or 8-poles that are switched simultaneously. The LU/LT Switches are available in DIN and BS standard.

Features

The robust and compact design of the Load Break Switches allows them to frequently be used for construction site power distribution, grid and back-up feed systems, railroad systems, utility applications and telecommunication.

Load Break Switches without Fuse-Links / Changeover-Switches

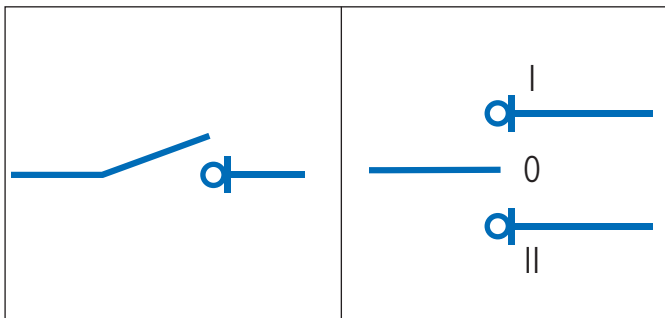

Load Break Switches with Fuse-Links

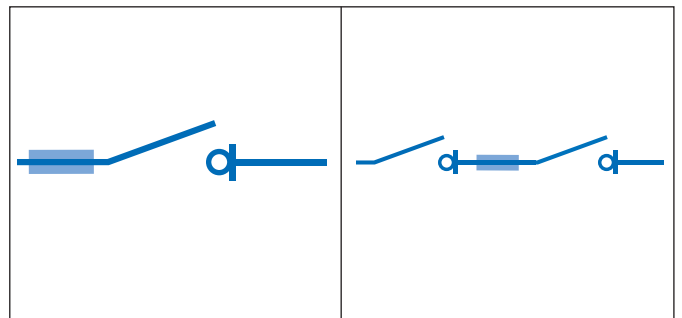

Changeover Switches / Load Break Switches / Switch-Fuses



Application:

- Switchboards, Panels
- Motor Control Centres

Design Features:

- High ratings and performance
- Strong knife-contact system
- Double break
- Visible contacts in Off-position.

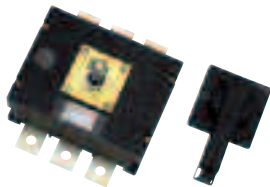
More information on request.

 For more information
see page **88**

29100-1500

Load Break Switches, 3- and 4-poles, 63 - 630 A, Type FWA

Description	Pole	Amps	Order-No.	PU	PG	Sur. Ag	Sur. Cu	Price €/pc.
Load Break Switch	3	63	29100-0401	1	LU/LT 2	0,003	0,010	70,50
Load Break Switch	4	63	29104-0401	1	LU/LT 2	0,002	0,010	73,80
Load Break Switch	3	80	29100-0501	1	LU/LT 2	0,003	0,010	73,80
Load Break Switch	4	80	29104-0501	1	LU/LT 2	0,004	0,015	78,00
Load Break Switch	3	100	29100-0601	1	LU/LT 2	0,003	0,010	78,00
Load Break Switch	4	100	29104-0601	1	LU/LT 2	0,004	0,015	82,20
Load Break Switch	3	125	29100-0700	1	LU/LT 2	0,010	0,028	114,50
Load Break Switch	4	125	29104-0700	1	LU/LT 2	0,012	0,038	130,00
Load Break Switch	3	160	29100-0800	1	LU/LT 2	0,010	0,028	120,00
Load Break Switch	4	160	29104-0800	1	LU/LT 2	0,012	0,038	135,00
Load Break Switch	3	200	29100-0900	1	LU/LT 2	0,012	0,038	142,50
Load Break Switch	4	200	29104-0900	1	LU/LT 2	0,014	0,050	160,00
Load Break Switch	3	250	29100-1000	1	LU/LT 2	0,028	0,074	248,50
Load Break Switch	4	250	29104-1000	1	LU/LT 2	0,014	0,050	296,00
Load Break Switch	3	315	29100-1200	1	LU/LT 2	0,012	0,038	273,00
Load Break Switch	4	315	29104-1200	1	LU/LT 2	0,014	0,050	315,00
Load Break Switch	3	400	29100-1300	1	LU/LT 2	0,029	0,085	297,00
Load Break Switch	4	400	29104-1300	1	LU/LT 2	0,042	0,129	335,00
Load Break Switch	3	500	29100-1400	1				on demand
Load Break Switch	4	500	29104-1400	1				on demand
Load Break Switch	4	630	29100-1500	1	LU/LT 2	0,016	0,048	412,50
Load Break Switch	4	630	29104-1500	1	LU/LT 2	0,022	0,066	463,00

 Combination for accesories see page **88**
Accessories for Load Break Switches, 3- and 4-poles, 63 - 630 A, Type FWA

Description	Pole	Amps	Order-No.	PU	PG	Sur. Ag	Sur. Cu	Price €/pc.
Door coupling + interlock shaft extension		63-100	36541-0010	1				on demand
Door coupling + interlock shaft extension		125-200	36509-0010	1				on demand
Door coupling + interlock shaft extension		250-630	36680-0010	1				on demand
Incoming terminal cover	3	63-100	31828-0200	1				on demand
Incoming terminal cover	4	63-100	31828-0100	1				on demand
Incoming terminal cover	3 + 4	125-200	36573-0010	1				on demand
Incoming terminal cover	3 + 4	250-630	36658-0010	1				on demand

Changeover Switches / Load Break Switches / Switch-Fuses



Application:

- Switchboards, Panels
- Motor Control Centres

Design Features:

- High ratings and performance
- Strong knife-contact system
- Double break
- Visible contacts in Off- position.

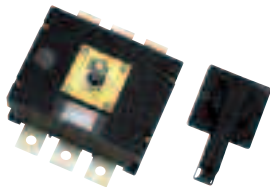
More information on request.

 For more information
see page **88**

29110-1500

Load Break Switches, 3- and 4-poles, 250 - 1250 A, Type FWA-HLD

Description	Pole	Amps	Order-No.	PU	PG	Sur. Ag	Sur. Cu	Price €/pc.
Load Break Switch	3	250	29110-1000	1	LU/LT 2	0,021	0,065	275,00
Load Break Switch	4	250	29114-1000	1	LU/LT 2	0,003	0,010	322,00
Load Break Switch	3	300	29110-1200	1	LU/LT 2	0,028	0,085	301,00
Load Break Switch	4	300	29114-1200	1				on demand
Load Break Switch	3	400	29110-1300	1				on demand
Load Break Switch	4	400	29114-1300	1	LU/LT 2	0,004	0,120	416,00
Load Break Switch	3	500	29110-1400	1				on demand
Load Break Switch	4	500	29114-1400	1	LU/LT 2	0,005	0,014	517,00
Load Break Switch	3	630	29110-1500	1	LU/LT 2	0,037	0,135	516,00
Load Break Switch	4	630	29114-1500	1	LU/LT 2	0,006	0,016	590,00
Load Break Switch	3	800	29110-1600	1				on demand
Load Break Switch	4	800	29114-1600	1	LU/LT 2	0,018	0,056	865,00
Load Break Switch	3	1000	29110-1700	1	LU/LT 2	0,041	0,140	883,00
Load Break Switch	4	1000	29114-1700	1	LU/LT 2	0,020	0,060	1.046,00
Load Break Switch	3	1250	29110-1800	1	LU/LT 2	0,060	0,164	1.180,00
Load Break Switch	4	1250	29114-1800	1	LU/LT 2	0,020	0,064	1.406,00

 Combination for accessories see page **88**
Accessories for Load Break Switches, 3- and 4-poles, 250 - 1250 A, Type FWA-HLD

Description	Pole	Amps	Order-No.	PU	PG	Sur. Ag	Sur. Cu	Price €/pc.
Incoming terminal cover	3 + 4	250-630	36658-0010	1				on demand
Door coupling + interlock shaft extension		250-630	36680-0010	1				on demand
Incoming terminal cover		250-630	36899-0010	1				on demand
Incoming terminal cover		800-1250	36857-0010	1				on demand
Aux contact 1NC 1NO in Pos. 1	3 + 4	250-630	36516-0010	1				on demand
Door coupling + interlock shaft extension	3 + 4	800-1250	36505-0010	1				on demand
Aux contact 1NC 1NO in Pos. 1	3 + 4	800-1250	36504-0010	1				on demand
Incoming terminal cover	3	800-1250	36586-0010	1				on demand
Incoming terminal cover	4	800-1250	36587-0010	1				on demand

Changeover Switches / Load Break Switches / Switch-Fuses



Application:

- Switchboards, Panels
- Motor Control Centres

Design Features:

- High ratings and performance
- Strong knife-contact system
- Double break
- Visible contacts in Off- position.

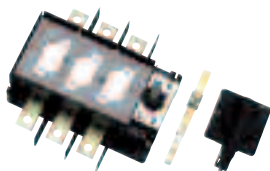
More information on request.

 For more information
see page **88**

29250-1100

Load Break Switches 3- and 4-poles, 63 - 300 A, Type FAM

Description	Pole	Amps	Order-No.	PU	PG	Sur. Ag	Sur. Cu	Price €/pc.
Load Break Switch	3	63	29250-0401	1	LU/LT 3	0,006	0,027	87,00
Load Break Switch	3	80	29250-0501	1	LU/LT 3	0,006	0,027	89,00
Load Break Switch	3	100	29250-0600	1	LU/LT 3	0,008	0,027	93,00
Load Break Switch	3	125	29250-0700	1	LU/LT 3	0,008	0,027	100,00
Load Break Switch	3	160	29250-0800	1	LU/LT 3	0,008	0,027	105,00
Load Break Switch	3	200	29250-0900	1	LU/LT 3	0,019	0,082	189,00
Load Break Switch	3	250	29250-1000	1	LU/LT 3	0,019	0,082	207,00
Load Break Switch	3	300	29250-1100	1	LU/LT 3	0,019	0,082	227,00

 Combination for accesories see page **90**
Accessories for Load Break Switches, 3- and 4-poles, 63 - 300 A, Type FAM

Description	Pole	Amps	Order-No.	PU	PG	Sur. Ag	Sur. Cu	Price €/pc.
Door coupling + interlock shaft extension	3	63-160	36593-0010	1				on demand
Aux contact 1NC 1NO in Pos. 1		200-300	36596-0010	1				on demand
Neutral pole (3 + N), with lug	*	63-125	36907-0010	1				on demand
Neutral pole (3 + N), with box terminal	*	63-125	36908-0010	1				on demand
Neutral pole (3 + N), with insertet screw	*	100-160	36906-0010	1				on demand
Incoming terminal shroud	3 + 4	200-300	36506-0010	1				on demand
Incoming terminal cover	3	100-160	36501-0010	1				on demand

* for additional 4-pole

Changeover Switches / Load Break Switches / Switch-Fuses

Application

- Switchboards, controlboards
- Panelboards
- Distribution boards

Design Features

- Small contact system
- High electrical performance
- Forced closing and opening of switch contacts
- Full isolation of fuse in "Off"-Position

Delivery includes

Switches are delivered complete with door coupling, interlock, shaft extension, padlockable handle and escutcheon plate.

More information (dimensions, technical data) on request.

For more information see page 88

Switch Fuses (DIN-Type) 3-poles and 3-poles+N, 63 - 125 A, Type SILA – NH 00

Description	Size	Pole	Amps	Order-No.	PU	PG	Sur. Ag	Sur. Cu	Price €/pc.
Switch Fuse	000/00	3	63	29400-0400	1	LU/LT 5	0,014	0,039	95,00
Switch Fuse	00	3	125	29400-0700	1	LU/LT 5	0,014	0,039	189,00

Combination for accessories see page 90

Accessories for Switch Fuses (DIN-Type) 3-poles and 3-poles+N, 63 - 125 A, Type SILA – NH 00

Description	Pole	Amps	Order-No.	PU	PG	Sur. Ag	Sur. Cu	Price €/pc.
Neutral pole (3 + N), with clamp			36909-0010	1				on demand
Neutral pole (3 + N), with lug, 185 mm length			36910-0010	1				on demand
Neutral pole (3 + N), with insertet screw			36911-0010	1				on demand
Incoming terminal shroud	3	63-125	36507-0010	1				on demand
Door coupling + interlock shaft extension	3	63-160	36593-0010	1				on demand

29400-0700

Changeover Switches / Load Break Switches / Switch-Fuses

Application

- Switchboards, controlboards
- Panelboards
- Distribution boards

Design Features

- Small contact system
- High electrical performance
- Forced closing and opening of switch contacts
- Full isolation of fuse in "Off"-Position

Delivery includes

Switches are delivered complete with door coupling, interlock, shaft extension, padlockable handle and escutcheon plate.

More information (dimensions, technical data) on request.

For more information see page 88



29410-0700

Switch Fuses (DIN-Type) 3-poles and 3-poles+N, 63 - 125 A, Type SILAD – NH 00

Description	Pole	Amps	Order-No.	PU	PG	Sur. Ag	Sur. Cu	Price €/pc.
Switch Fuse	3	63	29410-0400	1	LU/LT 5	0,017	0,057	184,00
Switch Fuse	3	125	29410-0700					on demand
Switch Fuse	3	250	29400-1000	1	LU/LT 5	0,029	0,101	278,00
Switch Fuse	3 + N	250	29403-1000	1	LU/LT 5	0,032	0,112	302,00
Switch Fuse	3	400	29420-1300	1	LU/LT 5	0,013	0,035	670,00
Switch Fuse	3 + N	400	29423-1300	1	LU/LT 5	0,013	0,035	715,00
Switch Fuse	3	630	29420-1500	1	LU/LT 5	0,014	0,038	980,00
Switch Fuse	3 + N	630	29423-1500	1	LU/LT 5	0,014	0,038	1.070,00

Accessories for Switch Fuses (DIN-Type) 3-poles and 3-poles+N, 63 - 125 A, Type SILAD – NH 00

Description	Pole	Amps	Order-No.	PU	PG	Sur. Ag	Sur. Cu	Price €/pc.
Neutral pole (3 + N), with lug	*	63-125	36907-0010	1				on demand
Neutral pole (3 + N), with box terminal	*	63-125	36908-0010	1				on demand
Neutral pole (3 + N), with insertet screw	*	100-160	36906-0010	1				on demand
Incoming terminal cover	3	100-160	36501-0010	1				on demand
Incoming terminal shroud	3 + 4	200-300	36506-0010	1				on demand
Incoming terminal cover	3	400	36589-0010	1				on demand
Incoming terminal cover	3	630	36591-0010	1				on demand

* for additional 4-pole

Changeover Switches / Load Break Switches / Switch-Fuses



Application

- Switchboards, controlboards
- Panelboards
- Distribution boards

Design Features

- Small contact system
- High electrical performance
- Forced closing and opening of switch contacts
- Full isolation of fuse in "Off"-Position

Delivery includes

Switches are delivered complete with door coupling, interlock, shaft extension, padlockable handle and escutcheon plate.

More information (dimensions, technical data) on request.

For more information see page 88



29430-0101 + 36908-0010

Switch fuses (BS88-Type), 3-poles and 3-poles+N, 25 - 125 A, Type SILA BS

Description	Size acc. to BS88	Pole	Amps	Order-No.	PU	PG	Sur. Ag	Sur. Cu	Price €/pc.
Switch fuses (BS88-Type)	F1	3	25	29430-0101	1	LU/LT 6	0,011	0,029	92,00
Switch fuses (BS88-Type)	F1	3	32	29430-0201	1	LU/LT 6	0,011	0,029	95,00
Switch fuses (BS88-Type)	A3	3	63	29430-0400	1	LU/LT 6	0,008	0,027	101,00
Switch fuses (BS88-Type)	A3	3	100	29430-0600	1	LU/LT 6	0,008	0,027	102,00
Switch fuses (BS88-Type)	A4	3	125	29430-0700	1	LU/LT 6	0,013	0,036	127,00

Combination for accessories see page 91

Accessories for Switch fuses (BS88-Type), 3-poles and 3-poles+N, 25 - 125 A, Type SILA BS

Description	Pole	Amps	Order-No.	PU	PG	Sur. Ag	Sur. Cu	Price €/pc.
Neutral pole (3 + N), with lug	*	63-125	36907-0010	1				on demand
Neutral pole (3 + N), with box terminal	*	63-125	36908-0010	1				on demand
Incoming terminal cover	3	100-160	36501-0010	1				on demand
Neutral pole (3 + N), with insertet screw	*	100-160	36906-0010	1				on demand

Changeover Switches / Load Break Switches / Switch-Fuses



Application

- Switchboards, controlboards
- Panelboards
- Distribution boards

Design Features

- Small contact system
- High electrical performance
- Forced closing and opening of switch contacts
- Full isolation of fuse in "Off"-Position

Delivery includes

Switches are delivered complete with door coupling, interlock, shaft extension, padlockable handle and escutcheon plate.

More information (dimensions, technical data) on request.

For more information see page 88

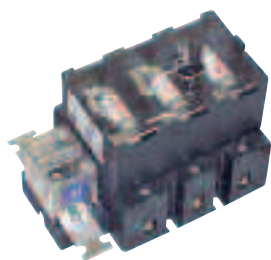

29440-0101 + 36908-0010

Switch fuses (BS88-Type), 3-poles and 3-poles+N, 25 - 125 A, Type SILAD BS

Description	Size acc. to BS 88	Pole	Amps	Order-No.	PU	PG	Sur. Ag	Sur. Cu	Price €/pc.
Switch fuses (BS88-Type)	A1	3	25	29440-0101	1	LU/LT 6	0,008	0,035	137,00
Switch fuses (BS88-Type)	A1	3	32	29440-0201	1	LU/LT 6	0,008	0,035	140,00
Switch fuses (BS88-Type)	A3	3	63	29440-0400	1	LU/LT 6	0,015	0,049	147,00
Switch fuses (BS88-Type)	A3	3	100	29440-0600	1	LU/LT 6	0,015	0,043	165,00
Switch fuses (BS88-Type)	B2	3	125	29440-0700	1	LU/LT 6	0,015	0,043	168,00
Switch fuses (BS88-Type)	B2	3	160	29440-0800	1	LU/LT 6	0,015	0,049	177,00
Switch fuses (BS88-Type)	B2	3	200	29440-0900	1	LU/LT 6	0,029	0,096	250,00
Switch fuses (BS88-Type)	B3	3	250	29440-1000	1	LU/LT 6	0,029	0,096	282,00
Switch fuses (BS88-Type)	B3	3	300	29440-1100	1	LU/LT 6	0,029	0,096	348,00

Combination for accessories see page 92

Accessories for Switch fuses (BS88-Type), 3-poles and 3-poles+N, 25 - 125 A, Type SILAD BS

Description	Pole	Amps	Order-No.	PU	PG	Sur. Ag	Sur. Cu	Price €/pc.
Neutral pole (3 + N), with lug	*	63-125	36907-0010	1				on demand
Neutral pole (3 + N), with box terminal	*	63-125	36908-0010	1				on demand
Incoming terminal shroud	3	63-125	36702-0100	1				on demand
Neutral pole (3 + N), with insertet screw	*	100-160	36906-0010	1				on demand
Incoming terminal shroud	3 + 4	200-300	36506-0010	1				on demand

* for additional 4-pole

Changeover Switches / Load Break Switches / Switch-Fuses

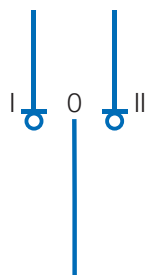
Application:

- Main generator switchboards
- Power supplies for airports, hospitals, broadcasting
- Switchboards at telecommunication systems

Design Features:

- Unique switching arrangement
- Unique L-shape moving contact
- High safety and performance
- Visible, strong knife contact system

More information on request.

* The 1-0-2 switching position would be prevent the parallel operation of nets. Also a short time operation are prevent.

For more information see page **88**

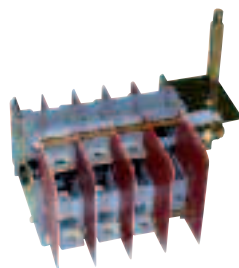

29300-0400

Load Changeover Switches 3- and 4-poles, 63 - 800 A Type, FMU (FMUN)

Description	Pole	Amps	Order-No.	PU	PG	Sur. Ag	Sur. Cu	Price €/pc.
Load Changeover Switch	3	63	29300-0400	1	LU/LT 1	0,013	0,048	253,00
Load Changeover Switch	4	63	29304-0400	1	LU/LT 1	0,017	0,064	194,00
Load Changeover Switch	3	80	29300-0500	1	LU/LT 1	0,013	0,048	162,00
Load Changeover Switch	4	80	29304-0500	1	LU/LT 1	0,017	0,064	205,00
Load Changeover Switch	3	100	29300-0600	1	LU/LT 1	0,013	0,048	170,00
Load Changeover Switch	4	100	29304-0600	1	LU/LT 1	0,017	0,064	208,00
Load Changeover Switch	3	125	29300-0700	1	LU/LT 1	0,013	0,048	171,00
Load Changeover Switch	4	125	29304-0700	1	LU/LT 1	0,017	0,064	216,00
Load Changeover Switch	3	160	29300-0800	1	LU/LT 1	0,016	0,041	194,00
Load Changeover Switch	4	160	29304-0800	1	LU/LT 1	0,022	0,054	231,00
Load Changeover Switch	3	200	29320-0900	1	LU/LT 1	0,023	0,081	391,00
Load Changeover Switch	4	200	29324-0900	1	LU/LT 1	0,031	0,108	438,00
Load Changeover Switch	3	250	29320-1000	1	LU/LT 1	0,023	0,081	457,00
Load Changeover Switch	4	250	29324-1000	1	LU/LT 1	0,031	0,108	516,00
Load Changeover Switch	3	300	29320-1100	1	LU/LT 1	0,052	0,126	559,00
Load Changeover Switch	4	300	29324-1100	1	LU/LT 1	0,066	0,168	607,00
Load Changeover Switch	3	400	29320-1300	1	LU/LT 1	0,050	0,126	654,00
Load Changeover Switch	4	400	29324-1300	1	LU/LT 1	0,066	0,168	726,00
Load Changeover Switch	3	500	29320-1400	1	LU/LT 1	0,050	0,126	816,00
Load Changeover Switch	4	500	29324-1400	1	LU/LT 1	0,066	0,168	909,00
Load Changeover Switch	3	630	29300-1500	1	LU/LT 1	0,016	0,052	1.216,00
Load Changeover Switch	4	630	29304-1500	1	LU/LT 1	0,010	0,042	1.533,00
Load Changeover Switch	3	800	29300-1600	1	LU/LT 1	0,089	0,327	1.522,00
Load Changeover Switch	4	800	29304-1600	1	LU/LT 1	0,018	0,056	1.906,00
Load Changeover Switch	3	1000	29300-1700	1	LU/LT 1	0,019	0,060	1.850,00
Load Changeover Switch	4	1000	29304-1700	1	LU/LT 1	0,018	0,060	2.193,00
Load Changeover Switch	3	1250	29300-1800	1	LU/LT 1	0,020	0,064	2.307,00
Load Changeover Switch	4	1250	29304-1800	1	LU/LT 1	0,020	0,064	2.745,00
Load Changeover Switch	3	1600	29300-1900	1	LU/LT 1	0,170	0,966	3.246,00
Load Changeover Switch	4	1600	29304-1900	1	LU/LT 1	0,025	0,088	4.060,00
Load Changeover Switch	3	2000	29300-2000	1	LU/LT 1	0,030	0,100	3.652,00
Load Changeover Switch	4	2000	29304-2000	1	LU/LT 1	0,030	0,100	4.560,00

Combination for accessories see page **92**

Accessories for Load Changeover Switches 3- and 4-poles, 63 - 800 A Type, FMU (FMUN)

Description	Pole	Amps	Order-No.	PU	PG	Sur. Ag	Sur. Cu	Price €/pc.
Door coupling + interlock shaft extension		63-250	36509-0010	1				on demand
Door coupling + interlock shaft extension	3 + 4	300-500	36505-0010	1				on demand
Door coupling + interlock shaft extension	3 + 4	630-1250	36515-0010	1				on demand
Door coupling + interlock shaft extension	3 + 4	1600-2000	36612-0010	1				on demand
Clamp cover for 2 sides, DKLAD	3 + 4	63-160	36503-0010	1				on demand
Clamp cover for 2 sides, DKLAD	3 + 4	200-250	36645-0010	1				on demand
Clamp cover for 2 sides, DKLAD	3 + 4	300-500	36588-0010	1				on demand
Clamp cover for 2 sides, DKLAD	4	630-1250	36651-0010	1				on demand
Clamp cover for 2 sides, DKLAD	3	630-1250	36703-0010	1				on demand
Clamp cover for 2 sides, DKLAD	3	1600-2000	36694-0010	1				on demand
Clamp cover for 2 sides, DKLAD	4	1600-2000	45149-0200	1				on demand

Load Changeover Switches in ST-Enclosure 3- and 4-poles, 63 - 2000 A Type FMU

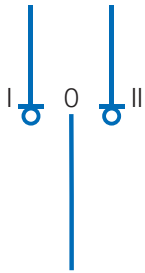

The Load Changeover Switches - Typ FMU - in a steel enclosure have some specials for the typical application - switching to alternative power supply

- Connection of on load with two energy sources
- Switch functions 1-0-2
- Breaker function, thus visible isolating distance

For more information see page **88**



29300-0410

Enclosure ST-FMU 6-16

- Enclosure size: 300 x 300 x 120 mm
- Terminal opening: 134 x 44 mm
- Protection: IP66
- Rated operational current: I_e AC 21B 415 V

Description	Pole	Amps	Order-No	PU	PG	Sur. AG	Sur. CU	Price €/pc.
ST-FMU 6/3 with screw terminal M6	3	63	29300-0410	1				on demand
ST-FMU 6/4 with screw terminal M6	4	63	29304-0410	1				on demand
ST-FMU 8/3 with screw terminal M6	3	80	29300-0510	1				on demand
ST-FMU 8/4 with screw terminal M6	4	80	29304-0510	1				on demand
ST-FMU 10/3 with screw terminal M6	3	100	29300-0610	1				on demand
ST-FMU 10/4 with screw terminal M6	4	100	29304-0610	1				on demand
ST-FMU 12/3 with screw terminal M6	3	125	29300-0710	1				on demand
ST-FMU 12/4 with screw terminal M6	4	125	29304-0710	1				on demand
ST-FMU 16/3 with screw terminal M8	3	160	29300-0810	1				on demand
ST-FMU 16/4 with screw terminal M8	4	160	29304-0810	1				on demand



29320-0910

Enclosure ST-FMUN 20-25

- Enclosure size: 300 x 400 x 210 mm
- Terminal opening: 234 x 48 mm
- Protection: IP66
- Rated operational current: I_e AC 21B 415 V

Description	Pole	Amps	Order-No	PU	PG	Sur. AG	Sur. CU	Price €/pc.
ST-FMUN 20/3 with screw terminal M10	3	200	29320-0910	1				on demand
ST-FMUN 20/4 with screw terminal M10	4	200	29324-0910	1				on demand
ST-FMUN 25/3 with screw terminal M10	3	250	29320-1010	1				on demand
ST-FMUN 25/4 with screw terminal M10	4	250	29324-1010	1				on demand



29320-1110

Enclosure ST-FMUN 30-50

- Enclosure size: 380 x 600 x 210 mm
- Terminal opening: 303 x 65 mm
- Protection: IP66
- Rated operational current: I_e AC 21B 415 V

Description	Pole	Amps	Order-No	PU	PG	Sur. AG	Sur. CU	Price €/pc.
ST-FMUN 30/3 with screw terminal M10	3	300	29320-1110	1				on demand
ST-FMUN 30/4 with screw terminal M10	4	300	29324-1110	1				on demand
ST-FMUN 40/3 with screw terminal M10	3	400	29320-1310	1				on demand
ST-FMUN 40/4 with screw terminal M10	4	400	29324-1310	1				on demand
ST-FMUN 50/3 with screw terminal M10	3	500	29320-1410	1				on demand
ST-FMUN 50/4 with screw terminal M10	4	500	29324-1410	1				on demand

Load Changeover Switches in ST-Enclosure 3- and 4- poles, 63 - 2000 A Type FMU

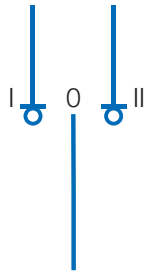

The Load Changeover Switches - Typ FMU - in a steel enclosure have some specials for the typical application - switching to alternative power supply

- Connection of on load with two energy sources
- Switch functions 1-0-2
- Breaker function, thus visible isolating distance

For more information see page **88**



29300-1510

Enclosure ST-FMUN 63-125

- Enclosure size: 500 x 700 x 250 mm
- Terminal opening: 303 x 114 mm
- Protection: IP56
- Rated operational current: I_e AC 21B 415 V

Description	Pole	Amps	Order-No	PU	PG	Sur. AG	Sur. CU	Price €/pc.
ST-FMU 63/3 with screw terminal M12	3	630	29300-1510	1				on demand
ST-FMU 63/4 with screw terminal M12	4	630	29304-1510	1				on demand
ST-FMU 80/3 with screw terminal M12	3	800	29300-1610	1				on demand
ST-FMU 80/4 with screw terminal M12	4	800	29304-1610	1				on demand
ST-FMU 100/3 with screw terminal M12	3	1000	29300-1710	1				on demand
ST-FMU 100/4 with screw terminal M12	4	1000	29304-1710	1				on demand
ST-FMU 125/3 with screw terminal M12	3	1250	29300-1810	1				on demand
ST-FMU 125/4 with screw terminal M12	4	1250	29304-1810	1				on demand

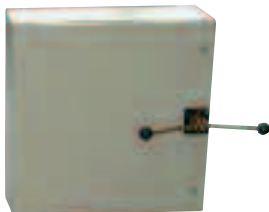

29300-1910

Enclosure ST-FMUN 160-200

- Enclosure size: 760 x 760 x 300 mm
- Terminal opening: 303 x 114 mm
- Protection: IP56
- Rated operational current: I_e AC 21B 415 V

Description	Pole	Amps	Order-No	PU	PG	Sur. AG	Sur. CU	Price €/pc.
ST-FMU 160/3 with screw terminal M12	3	1600	29300-1910	1				on demand
ST-FMU 160/4 with screw terminal M12	4	1600	29304-1910	1				on demand
ST-FMU 200/3 with screw terminal M12	3	2000	29300-2010	1				on demand
ST-FMU 200/4 with screw terminal M12	4	2000	29304-2010	1				on demand

Accessories

For more information
see page **88**

Accessories

Description	Pole	Amps	Order-No.	PU	PG	Sur. Ag	Sur. Cu	Price €/pc.
Position indicating in switch position 1 and 2		63-250	36659-0010	1				on demand
Position indicating in switch position 1 and 2		300-1250	36665-0010	1				on demand
Position indicating in switch position 1 and 2		1600-2000	36625-0010	1				on demand
Incoming terminal cover	3 + 4	63-160	36503-0010	1				on demand
Incoming terminal cover	3 + 4	200-250	36645-0010	1				on demand
Incoming terminal cover	3 + 4	300-500	36588-0010	1				on demand
Incoming terminal cover	4	630-1250	36651-0010	1				on demand
Incoming terminal cover	4	800-1250	36587-0010	1				on demand
Incoming terminal cover	3	1600-2000	36694-0010	1				on demand

Changeover Switches / Load Break Switches / Switch-Fuses

Application:

- Machine tools, injection moulding machines
- Main switch boards
- Control boards

Design Features:

- Modular, compact design
- High electrical performance AC 23
- Various optional accessories

More information on request.

 For more information see page **88**

29160-1000

Main Switches, 3- and 4-poles, 250 - 1250 A, Type HSWA

Description	Pole	Amps	Order-No.	PU	PG	Sur. Ag	Sur. Cu	Price €/pc.
Main Switches	3	250	29160-1000	1	LU/LT 2	0,012	0,038	287,00
Main Switches	4	250	29164-1000	1	LU/LT 2	0,014	0,050	340,00
Main Switches	3	315	29160-1200	1	LU/LT 2	0,012	0,038	314,00
Main Switches	4	315	29164-1200	1	LU/LT 2	0,019	0,065	358,00
Main Switches	3	400	29160-1300	1	LU/LT 2	0,016	0,045	382,00
Main Switches	4	400	29164-1300	1	LU/LT 2	0,024	0,136	427,00
Main Switches	3	500	29160-1400	1	LU/LT 2	0,018	0,100	457,00
Main Switches	4	500	29164-1400	1	LU/LT 2	0,024	0,136	531,00
Main Switches	3	630	29160-1500	1	LU/LT 2	0,018	0,100	528,00
Main Switches	4	630	29164-1500	1	LU/LT 2	0,024	0,136	601,00
Main Switches	3	800	29160-1600	1	LU/LT 2	0,018	0,100	660,00
Main Switches	4	800	29164-1600	1	LU/LT 2	0,024	0,136	888,00
Main Switches	3	1000	29160-1700	1	LU/LT 2	0,018	0,100	908,00
Main Switches	4	1000	29164-1700	1	LU/LT 2	0,024	0,136	1.070,00
Main Switches	3	1250	29160-1800	1	LU/LT 2	0,020	0,120	1.205,00
Main Switches	4	1250	29164-1800	1	LU/LT 2	0,024	0,136	1.428,00

 Combination for accessories see page **93**
Accessories for Main Switches, 3- and 4-poles, 250 - 1250 A, Type HSWA

Description	Pole	Amps	Order-No.	PU	PG	Sur. Ag	Sur. Cu	Price €/pc.
Incoming terminal cover	3	63-100	31828-0200	1				on demand
Incoming terminal cover	4	63-100	31828-0100	1				on demand
Incoming terminal cover	3 + 4	125-200	36573-0010	1				on demand
Incoming terminal cover	3 + 4	250-630	36658-0010	1				on demand
Aux contact 1NC 1NO in Pos. 1	3 + 4	250-630	36516-0010	1				on demand
Aux contact 1NC 1NO in Pos. 1	3 + 4	800-1250	36504-0010	1				on demand

Changeover Switches / Load Break Switches / Switch-Fuses

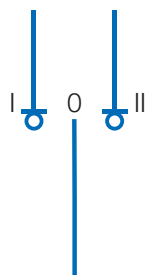

Application:

- Main generator switchboards
- Power supplies for airports, hospitals, broadcasting
- Switchboards at telecommunication systems

Design Features:

- Unique switching arrangement
- Unique L-shape moving contact
- High safety and performance
- Visible, strong knife contact system

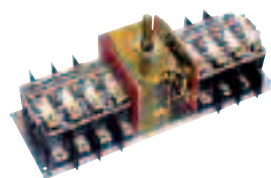
More information on request.

 For more information see page **88**

29360-0400

Bypass Switches 3- and 4-poles, 63 - 800 A, Type FMU BY 1 (FMUN BY1)

Description	Pole	Amps	Order-No.	PU	PG	Sur. Ag	Sur. Cu	Price €/pc.
Bypass Switch	3	63	29360-0400	1	LU/LT 1	0,026	0,096	382,00
Bypass Switch	4	63	29364-0400	1	LU/LT 1	0,035	0,128	485,00
Bypass Switch	3	80	29360-0500	1	LU/LT 1	0,007	0,026	405,00
Bypass Switch	4	80	29364-0500	1	LU/LT 1	0,035	0,128	513,00
Bypass Switch	3	100	29360-0600	1	LU/LT 1	0,026	0,096	427,00
Bypass Switch	4	100	29364-0600	1	LU/LT 1	0,035	0,128	522,00
Bypass Switch	3	125	29360-0700	1	LU/LT 1	0,007	0,026	447,00
Bypass Switch	4	125	29364-0700	1	LU/LT 1	0,035	0,128	541,00
Bypass Switch	3	160	29360-0800	1	LU/LT 1	0,033	0,082	485,00
Bypass Switch	4	160	29364-0800	1	LU/LT 1	0,044	0,109	577,00
Bypass Switch	3	200	29360-0900	1	LU/LT 1	0,010	0,027	977,00
Bypass Switch	4	200	29364-0900	1	LU/LT 1	0,062	0,217	1.101,00
Bypass Switch	3	250	29360-1000	1	LU/LT 1	0,047	0,163	1.140,00
Bypass Switch	4	250	29364-1000	1	LU/LT 1	0,062	0,217	1.294,00
Bypass Switch	3	300	29360-1100	1	LU/LT 1	0,100	0,252	1.400,00
Bypass Switch	4	300	29364-1100	1	LU/LT 1	0,133	0,336	1.522,00
Bypass Switch	3	400	29360-1300	1	LU/LT 1	0,100	0,252	1.636,00
Bypass Switch	4	400	29364-1300	1	LU/LT 1	0,133	0,336	1.819,00
Bypass Switch	3	500	29360-1400	1	LU/LT 1	0,100	0,252	2.040,00
Bypass Switch	4	500	29364-1400	1	LU/LT 1	0,133	0,336	2.270,00
Bypass Switch	3	630	29360-1500	1	LU/LT 1	0,012	0,052	3.045,00
Bypass Switch	4	630	29364-1500	1	LU/LT 1	0,015	0,065	3.835,00
Bypass Switch	3	800	29360-1600	1	LU/LT 1	0,016	0,056	3.800,00
Bypass Switch	4	800	29364-1600	1	LU/LT 1	0,016	0,075	4.770,00

 Combination for accessories see page **94**
Accessories for Bypass Switches 3- and 4-poles, 63 - 800 A, Type FMU BY 1 (FMUN BY1)

Description	Pole	Amps	Order-No.	PU	PG	Sur. Ag	Sur. Cu	Price €/pc.
Door coupling + interlock shaft extension		63-250	36509-0010	1				on demand
Door coupling + interlock shaft extension	3 + 4	300-500	36505-0010	1				on demand
Door coupling + interlock shaft extension	3 + 4	1600-2000	36612-0010	1				on demand
Door coupling + interlock shaft extension	3 + 4	630-1250	36515-0010	1				on demand
Incoming terminal shroud	3 + 4	63-160	36503-0010	1				on demand
Incoming terminal shroud	3 + 4	200-250	36645-0010	1				on demand
Incoming terminal shroud	3 + 4	300-500	36588-0010	1				on demand
Incoming terminal shroud	4	630-1250	36651-0010	1				on demand
Incoming terminal shroud	3	630-1250	36703-0010	1				on demand
Incoming terminal cover only DKLAD	3	1600-2000	36694-0010	1				on demand
Incoming terminal cover only DKLAD	4	1600-2000	45149-0200	1				on demand

Changeover Switches / Load Break Switches / Switch-Fuses

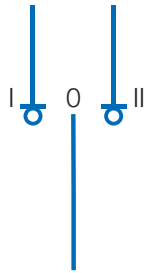

Application:

- Main generator switchboards
- Power supplies for airports, hospitals, broadcasting
- Switchboards at telecommunication systems

Design Features:

- Unique switching arrangement
- Unique L-shape moving contact
- High safety and performance
- Visible, strong knife contact system

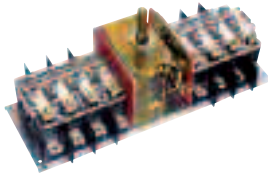
More information on request.

 For more information see page **88**

29360-1700

Bypass Switches 3- and 4-poles, 1000 - 2000 A, Type FMU BY1

Description	Pole	Amps	Order-No.	PU	PG	Sur. Ag	Sur. Cu	Price €/pc.
Bypass Switch	3	1000	29360-1700	1	LU/LT 1	0,018	0,060	4.615,00
Bypass Switch	4	1000	29364-1700	1	LU/LT 1	0,016	0,075	5.480,00
Bypass Switch	3	1250	29360-1800	1	LU/LT 1	0,020	0,065	5.770,00
Bypass Switch	4	1250	29364-1800	1	LU/LT 1	0,017	0,080	6.850,00
Bypass Switch	3	1600	29360-1900	1	LU/LT 1	0,025	0,088	8.110,00
Bypass Switch	4	1600	29364-1900	1	LU/LT 1	0,017	0,088	10.140,00
Bypass Switch	3	2000	29360-2000	1	LU/LT 1	0,030	0,100	9.120,00
Bypass Switch	4	2000	29364-2000	1	LU/LT 1	0,025	0,100	11.410,00

 Combination for accessories see page **94**
Accessories for Bypass Switches 3- and 4-poles, 1000 - 2000 A, Type FMU BY1

Description	Pole	Amps	Order-No.	PU	PG	Sur. Ag	Sur. Cu	Price €/pc.
Door coupling + interlock shaft extension	3 + 4	630-1250	36515-0010	1				on demand
Door coupling + interlock shaft extension	3 + 4	1600-2000	36612-0010	1				on demand
Incoming terminal shroud	4	630-1250	36651-0010	1				on demand
Incoming terminal shroud	3	630-1250	36703-0010	1				on demand

LU/LT

Changeover Switches /
 Load Break Switches / Switch-Fuses

Technical data

Type FMU BY1 (FMUN BY1): 63 - 800 A / AC21B 415V

Order No.	Type	Overall dimensions W x H x D	Order No. TKV- WV; door cou- pling, interlock, shaft extension	Order No. KLAD; overall terminal shroud	Rated uninter- rupted current I _u	Rated oper. current I _e AC21B 415V	No. of Poles	Maximum conductor cross section
29360-0400	FMU BY1-6/3	352x150x110	36540-0010	2x36503-0010	63A	63A	3	25 mm ²
29364-0400	FMU BY1-6/4	352x150x110	36540-0010	2x36503-0010	63A	63A	4	25 mm ²
29360-0500	FMU BY1-8/3	352x150x110	36540-0010	2x36503-0010	80A	80A	3	25 mm ²
29364-0500	FMU BY1-8/4	352x150x110	36540-0010	2x36503-0010	80A	80A	4	25 mm ²
29360-0600	FMU BY1-10/3	352x150x110	36540-0010	2x36503-0010	100A	100A	3	25 mm ²
29364-0600	FMU BY1-10/4	352x150x110	36540-0010	2x36503-0010	100A	100A	4	25 mm ²
29360-0700	FMU BY1-12/3	352x150x110	36540-0010	2x36503-0010	125A	125A	3	35 mm ²
29364-0700	FMU BY1-12/4	352x150x110	36540-0010	2x36503-0010	125A	125A	4	35 mm ²
29360-0800	FMU BY1-16/3	352x218x110	36540-0010	2x36503-0010	160A	160A	3	70 mm ²
29364-0800	FMU BY1-16/4	352x218x110	36540-0010	2x36503-0010	160A	160A	4	70 mm ²
29360-0900	FMUN BY1-20/3	474x181x110	36540-0010	2x36645-0010	200A	200A	3	120 mm ²
29364-0900	FMUN BY1-20/4	474x181x110	36540-0010	2x36645-0010	200A	200A	4	120 mm ²
29360-1000	FMUN BY1-25/3	474x181x110	36540-0010	2x36645-0010	250A	250A	3	150 mm ²
29364-1000	FMUN BY1-25/4	474x181x110	36540-0010	2x36645-0010	250A	250A	4	150 mm ²
29360-1100	FMUN BY1-30/3	570x285x159	36515-0010	2x36588-0010	300A	300A	3	185 mm ²
29364-1100	FMUN BY1-30/4	570x285x159	36515-0010	2x36588-0010	300A	300A	4	185 mm ²
29360-1300	FMUN BY1-40/3	570x285x159	36515-0010	2x36588-0010	400A	400A	3	240 mm ²
29364-1300	FMUN BY1-40/4	570x285x159	36515-0010	2x36588-0010	400A	400A	4	240 mm ²
29360-1400	FMUN BY1-50/3	570x285x159	36515-0010	2x36588-0010	500A	500A	3	300 mm ²
29364-1400	FMUN BY1-50/4	570x285x159	36515-0010	2x36588-0010	500A	500A	4	300 mm ²
29360-1500	FMU BY1-63/3	775x245x200	36515-0010	on demand	630A	on demand	3	2x185 mm ²
29364-1500	FMU BY1-63/4	945x245x200	36515-0010	2x36651-0010	630A	on demand	4	2x185 mm ²
29360-1600	FMU BY1-80/3	775x253x200	36515-0010	on demand	800A	on demand	3	2x185 mm ²
29364-1600	FMU BY1-80/4	945x253x200	36515-0010	2x36651-0010	800A	on demand	4	2x185 mm ²

Type FMU BY1: 1000 - 2000 A / AC21B 415V

Order No.	Type	Overall dimensions W x H x D	Order No. TKV- WV; door cou- pling, interlock, shaft extension	Order No. KLAD; overall terminal shroud	Rated uninter- rupted current I _u	Rated oper. current I _e AC21B 415V	No. of Poles	Maximum conductor cross section
29360-1700	FMU BY1-100/3	775x253x200	36515-0010	on demand	1000A	on demand	3	2x240 mm ²
29364-1700	FMU BY1-100/4	945x253x200	36515-0010	2x36651-0010	1000A	on demand	4	2x240 mm ²
29360-1800	FMU BY1-125/3	775x253x200	36515-0010	on demand	1250A	on demand	3	2x40x5 mm
29364-1800	FMU BY1-125/4	945x253x200	36515-0010	2x36651-0010	1250A	on demand	4	2x40x5 mm
29360-1900	FMU BY1-160/3	925x410x255	36612-0010	36694-0010	1600A	on demand	3	2x60x5 mm
29364-1900	FMU BY1-160/4	1125x410x255	36612-0010	36587-0010	1600A	on demand	4	2x60x5 mm
29360-2000	FMU BY1-200/3	925x410x255	36612-0010	36694-0010	2000A	on demand	3	2x80x5 mm
29364-2000	FMU BY1-200/4	1125x410x255	36612-0010	36587-0010	2000A	on demand	4	2x80x5 mm

Changeover Switches /
 Load Break Switches / Switch-Fuses

Technical data

Typee FWA: 63 - 630 A / AC22B 415V

Order no.	Type	Overall dimensions W x H x D	Order No. TKV- WV; door cou- pling, interlock, shaft extension	Order No. KLAD; inco- ming ter- minal shroud	Rated uninter- rupted current I _u	Rated oper. current I _e AC22B 415V	Rated oper. current I _e AC23B 415V	No. of Poles	Maximum conductor cross section
29100-0401	FWA 6/3K	72x104x 71	36541-0010	31828-0200	63A	63A		3	35 mm ²
29104-0401	FWA 6/4K	72x 82x 71	36541-0010	31828-0100	63A	on demand		4	35 mm ²
29100-0501	FWA 8/3K	72x104x 71	36541-0010	31828-0200	80A	80A		3	35 mm ²
29104-0501	FWA 8/4K	72x 82x 71	36541-0010	31828-0100	80A	on demand		4	35 mm ²
29100-0601	FWA 10/3K	72x104x 71	36541-0010	31828-0200	100A	100A		3	35 mm ²
29104-0601	FWA 10/4K	72x 82x 71	36541-0010	31828-0100	100A	on demand		4	35 mm ²
29100-0700	FWA 12/3K	122x132x 86	36509-0010	36573-0010	125A	125A		3	50 mm ²
29104-0700	FWA 12/4K	121x145x 84	36509-0010	36573-0010	125A	on demand		4	50 mm ²
29100-0800	FWA 16/3K	122x132x 86	36509-0010	36573-0010	160A	160A		3	70 mm ²
29104-0800	FWA 16/4K	121x145x 84	36509-0010	36573-0010	160A	on demand		4	70 mm ²
29100-0900	FWA 20/3K	122x132x 86	36509-0010	36573-0010	200A	200A		3	150 mm ²
29104-0900	FWA 20/4K	121x145x 84	36509-0010	36573-0010	200A	on demand		4	150 mm ²
29100-1000	FWA 25/3K	200x210x118	36680-0010	36658-0010	250A	250A		3	185 mm ²
29104-1000	FWA 25/4K	208x210x118	36680-0010	36658-0010	250A	on demand		4	185 mm ²
29100-1200	FWA 30/3K	200x210x118	36680-0010	36658-0010	315A	315A		3	195 mm ²
29104-1200	FWA 30/4K	208x210x118	36680-0010	36658-0010	315A	on demand		4	195 mm ²
29100-1300	FWA 40/3K	200x210x118	36680-0010	36658-0010	400A	400A		3	240 mm ²
29104-1300	FWA 40/4K	208x210x118	36680-0010	36658-0010	400A	on demand		4	240 mm ²
29100-1400	FWA 50/3	200x210x118	36680-0010	36658-0010	500A	on demand		3	240 mm ²
29104-1400	FWA 50/3	208x225x118	36680-0010	36658-0010	500A	on demand		4	240 mm ²
29100-1500	FWA 63/3K	200x225x118	36680-0010	36658-0010	630A	630A		3	240 mm ²
29104-1500	FWA 63/4K	200x232x118	36680-0010	36658-0010	630A	on demand		4	240 mm ²

LU/LT

 Changeover Switches /
 Load Break Switches / Switch-Fuses

Technical data

Type FWA-HLD: 250 - 1250 A / AC22B 415 V / AC23B 415V

Order no.	Type	Overall dimensions W x H x D	Order No. TKV- WV; door cou- pling, interlock, shaft extension	Order No. KLAD; inco- ming ter- minal shroud	Rated uninter- rupted current I _u	Rated oper. current I _e AC22B 415V	Rated oper. current I _e AC23B 415V	No. of Poles	Maximum conductor cross section
29110-1000	FWA-HLD 25/3K	200x210x118	36680-0010	36658-0010	250A	250A	250A	3	185 mm ²
29114-1000	FWA-HLD 25/4K	208x210x118	36680-0010	36658-0010	250A	250A	250A	4	185 mm ²
29110-1200	FWA-HLD 30/3K	200x210x118	36680-0010	36658-0010	300A	300A	250A	3	195 mm ²
29114-1200	FWA-HLD 30/4K	208x210x118	36680-0010	36658-0010	300A	300A	250A	4	195 mm ²
29110-1300	FWA-HLD 40/3K	200x210x118	36680-0010	36658-0010	400A	400A	250A	3	240 mm ²
29114-1300	FWA-HLD 40/4K	208x210x118	36680-0010	36658-0010	400A	400A	250A	4	240 mm ²
29110-1400	FWA-HLD 50/3K	200x225x118	36680-0010	36658-0010	500A	500A	400A	3	2x150 mm ²
29114-1400	FWA-HLD 50/4K	208x232x118	36680-0010	36658-0010	500A	500A	400A	4	2x150 mm ²
29110-1500	FWA-HLD 63/3K	200x225x118	36680-0010	36658-0010	630A	630A	400A	3	2x185 mm ²
29114-1500	FWA-HLD 63/4K	208x232x118	36680-0010	36658-0010	630A	630A	400A	4	2x185 mm ²
29110-1600	FWA-HLD 80/3	280x260x160	36505-0010	36658-0010	800A	800A	500A	3	2x185 mm ²
29114-1600	FWA-HLD 80/4	360x260x160	36505-0010	36658-0010	800A	800A	500A	4	2x185 mm ²
29110-1700	FWA-HLD 100/3	280x260x160	36505-0010	36658-0010	1000A	1000A	500A	3	2x240 mm ²
29114-1700	FWA-HLD 100/4	360x260x160	36505-0010	36658-0010	1000A	1000A	500A	4	2x240 mm ²
29110-1800	FWA-HLD 125/3	280x260x160	36505-0010	36658-0010	1250A	1250A	500A	3	2x300 mm ²
29114-1800	FWA-HLD 125/4	360x260x160	36505-0010	36658-0010	1250A	1250A	500A	4	2x300 mm ²

Changeover Switches /
 Load Break Switches / Switch-Fuses

Technical data

Type FAM: 63 - 300 A / AC21B 690 V / AC22B 415V

Order no.	Type	Overall dimensions W x H x D	Order No. H1S10; aux contact 1NC 1NO in Pos. 1	Order No. KLAD; incoming ter- minal shroud	Rated uninter- rupted current I _u	Rated oper. current I _e AC21B 690V	Rated oper. current I _e AC22B 415V	No. of Poles	Maximum conductor cross section
29250-0401	FAM 6/3	114x 95x72	36593-0010 *	integrated	63A	63A	63A	3	25 mm ²
29250-0501	FAM 8/3	114x 95x72	36593-0010 *	integrated	80A	80A	80A	3	25 mm ²
29250-0600	FAM 10/3	114x110x72	36593-0010 *	36702-0010	100A	100A	80A	3	70 mm ²
29250-0700	FAM 12/3	114x110x 72	36593-0010 *	36702-0010	125A	125A	80A	3	70 mm ²
29250-0800	FAM 16/3	114x110x 72	36593-0010 *	36702-0010	160A	160A	100A	3	70 mm ²
29250-0900	FAM 20/3	208x210x 94	36596-0010	36506-0010	200A	200A	200A	3	150 mm ²
29250-1000	FAM 25/3	208x210x 94	36596-0010	36506-0010	250A	250A	200A	3	150 mm ²
29250-1100	FAM 30/3	208x210x 94	36596-0010	36506-0010	300A	300A	250A	3	240 mm ²

* Remark: auxiliary contact 1c/o

Order no.	Type	Accessories
36906-0010	box terminal	Neutral for 3 pole +N
36907-0010	lug terminal	Neutral for 3 pole +N
36908-0010	multiple use terminal	Neutral for 3 pole +N

 Changeover Switches /
 Load Break Switches / Switch-Fuses

Technical data

Type SILA: 63 - 125 A / AC22B 415V

Order no.	Type	Overall dimensions W x H x D	Order No. H1S10; aux contact 1NC 1NO in Pos. 1	Order No. KLAD; incoming ter- minal shroud	Rated uninter- rupted current I _u	Rated oper. current I _e AC22B 415V	Fuse size acc. to DIN	No. of Poles	Maximum conductor cross section
29400-0400	SILA-NH 00-6/3-SE	114x183x72	36593-0010 *	36501-0010	63A	63A	000/00	3	16-70 mm ²
29400-0700	SILA 00-12/3-SE	114x183x72	36593-0010 *	36501-0010	125A	125A	00	3	16-70 mm ²

* Notice: Contact assembly = 1 two-way contact

Order no.	Type	Accessories
36909-0010	box terminal	Neutral for 3 pole +N
36910-0010	lug terminal	Neutral for 3 pole +N
36911-0010	multiple use terminal	Neutral for 3 pole +N

Changeover Switches /
 Load Break Switches / Switch-Fuses

Technical data

Type SILAD-NH: 63 - 630 A / AC22B 415V

Order no.	Type	Overall dimensions W x H x D	Order No. H1S10; aux contact 1NC 1NO in Pos. 1	Order No. H1S10; aux contact 1NC 1NO in Pos. 1	Rated uninter- rupted current I _u	Rated oper. current I _e AC22B 415V	Fuse size acc. to DIN	No. of Poles	Maximum conductor cross section
29410-0400	SILAD 00-6/3-SE	120x140x140	on demand	36507-0010	63A	63A	000/00	3	16- 70 mm ²
29410-0700	SILAD 00-12/3-SE	120x140x140	on demand	36507-0010	125A	125A	00	3	16- 70 mm ²
29400-1000	SILAD 1-25/3-SE	208x210x145	on demand	36506-0010	250A	250A	1	3	50-150 mm ²
29403-1000	SILAD 1-25/3+N-SE	208x210x145	on demand	36506-0010	250A	250A	1	3+N	50-150 mm ²
29420-1300	SILAD 2-40/3-SE	256x160x195	on demand	36589-0010	400A	400A	2	3	95-240 mm ²
29423-1300	SILAD 2-40/3+N-SE	256x160x195	on demand	36589-0010	400A	400A	2	3+N	95-240 mm ²
29420-1500	SILAD 3-63/3-SE	324x238x230	on demand	36591-0010	630A	630A	3	3	120-300 mm ²
29423-1500	SILAD 3-63/3+N-	324x238x230	on demand	36591-0010	630A	630A	3	3+N	120-300 mm ²

Order no.	Type	Accessories
36906-0010	box terminal	Neutral for 3 pole +N
36907-0010	lug terminal	Neutral for 3 pole +N
36908-0010	multiple use terminal	Neutral for 3 pole +N

LU/LT

 Changeover Switches /
 Load Break Switches / Switch-Fuses

Technical data

Type SILA: 25 - 125 A / AC22B 415V

Order no.	Type	Overall dimensions W x H x D	Order No. H1S10; aux contact 1NC 1NO in Pos. 1	Order No. H1S10; aux contact 1NC 1NO in Pos. 1	Rated uninter- rupted current I _u	Rated oper. current I _e AC22B 415V	Fuse size acc. to BS88	No. of Poles	Maximum conductor cross section
29430-0101	SILA-BS 2/3	100x134x77	-	box terminal	25A	25A	F1	3	2,5-25 mm ²
29430-0201	SILA-BS 3/3	100x134x77	-	box terminal	32A	32A	F1	3	2,5-25 mm ²
29430-0400	SILA-BS 6/3	114x202x72	on demand	36501-0010	63A	63A	A3	3	6 -50 mm ²
29430-0600	SILA-BS 10/3	114x202x72	on demand	36501-0010	100A	100A	A3	3	16 -70 mm ²
29430-0700	SILA-BS 12/3	114x202x72	on demand	36501-0010	125A	125A	A4	3	16 -70 mm ²

Order no.	Type	Accessories
36906-0010	box terminal	Neutral for 3 pole +N
36907-0010	lug terminal	Neutral for 3 pole +N
36908-0010	multiple use terminal	Neutral for 3 pole +N

Changeover Switches /
 Load Break Switches / Switch-Fuses

Technical data

Type SILAD-BS: 25 - 300 A / AC22B 415V

Order No.	Type	Overall dimensions W x H x D	Order No. H1S10; aux contact 1NC 1NO in Pos. 1	Order No. KLAD; incoming terminal shroud	Rated uninter- rupted current I _u	Rated oper. current I _e AC22B 415V	Fuse size acc. to BS88	No. of Poles	Maximum conductor cross section
29440-0101	SILAD-BS 2/3	114x 95x 98	-	box terminal	25A	25A	A1	3	6- 25 mm ²
29440-0201	SILAD-BS 3/3	114x 95x 98	-	box terminal	32A	32A	A1	3	6- 25 mm ²
29440-0400	SILAD-BS 6/3	114x 95x 98	on demand	36507-0010	63A	63A	A3	3	6- 25 mm ²
29440-0600	SILAD-BS 10/3	114x 95x 98	on demand	36507-0010	100A	100A	A3	3	16- 70 mm ²
29440-0700	SILAD-BS 12/3	114x 95x 98	on demand	36507-0010	125A	125A	B2	3	25- 70 mm ²
29440-0800	SILAD-BS 16/3	208x210x125	36596-0010	36506-0010	160A	160A	B2	3	25- 70 mm ²
29440-0900	SILAD-BS 20/3	208x210x125	36596-0010	36506-0010	200A	200A	B2	3	35- 95 mm ²
29440-1000	SILAD-BS 25/3	208x210x125	36596-0010	36506-0010	250A	250A	B3	3	50-150 mm ²
29440-1100	SILAD-BS 30/3	208x210x125	36596-0010	36506-0010	300A	300A	B3	3	70-185 mm ²

Order no.	Type	Accessories
36906-0010	box terminal	Neutral for 3 pole +N
36907-0010	lug terminal	Neutral for 3 pole +N
36908-0010	multiple use terminal	Neutral for 3 pole +N

 Changeover Switches /
 Load Break Switches / Switch-Fuses

Technical data

Type FMU (FMUN): 63 - 800 A / AC21B 415V

Order No.	Type	Overall dimensions W x H x D	Order No. TKV-WV; door coupling, interlock, shaft extension	Order No. KLAD; overall terminal shroud	Rated uninter- rupted current I _u	Rated oper. current I _e AC21B 415V	No. of Poles	Maximum conductor cross section
29300-0400	FMU 6/3	189x150x 98	36509-0010	36503-0010	63A	63A	3	25 mm ²
29304-0400	FMU 6/4	189x150x 98	36509-0010	36503-0010	63A	63A	4	25 mm ²
29300-0500	FMU 8/3	189x150x 98	36509-0010	36503-0010	80A	80A	3	25 mm ²
29304-0500	FMU 8/4	189x150x 98	36509-0010	36503-0010	80A	80A	4	25 mm ²
29300-0600	FMU 10/3	189x150x 98	36509-0010	36503-0010	100A	100A	3	25 mm ²
29304-0600	FMU 10/4	189x150x 98	36509-0010	36503-0010	100A	100A	4	25 mm ²
29300-0700	FMU 12/3	189x150x 98	36509-0010	36503-0010	125A	125A	3	35 mm ²
29304-0700	FMU 12/4	189x150x 98	36509-0010	36503-0010	125A	125A	4	35 mm ²
29300-0800	FMU 16/3	189x150x 98	36509-0010	36503-0010	160A	160A	3	70 mm ²
29304-0800	FMU 16/4	189x150x 98	36509-0010	36503-0010	160A	160A	4	70 mm ²
29320-0900	FMUN 20/3	245x181x 95	36509-0010	36645-0010	200A	200A	3	120 mm ²
29324-0900	FMUN 20/4	245x181x 95	36509-0010	36645-0010	200A	200A	4	120 mm ²
29320-1000	FMUN 25/3	245x181x 95	36509-0010	36645-0010	250A	250A	3	150 mm ²
29324-1000	FMUN 25/4	245x181x 95	36509-0010	36645-0010	250A	250A	4	150 mm ²
29320-1100	FMUN 30/3	286x285x143	36505-0010	36588-0010	300A	300A	3	185 mm ²
29324-1100	FMUN 30/4	286x285x143	36505-0010	36588-0010	300A	300A	4	185 mm ²
29320-1300	FMUN 40/3	286x285x143	36505-0010	36588-0010	400A	400A	3	240 mm ²
29324-1300	FMUN 40/4	286x285x143	36505-0010	36588-0010	400A	400A	4	240 mm ²
29320-1400	FMUN 50/3	286x285x143	36505-0010	36588-0010	500A	500A	3	300 mm ²
29324-1400	FMUN 50/4	286x285x143	36505-0010	36588-0010	500A	500A	4	300 mm ²
29300-1500	FMU 63/3	390x245x180	36515-0010	36703-0010	630A	630A	3	2x185 mm ²
29304-1500	FMU 63/4	475x245x180	36515-0010	36651-0010	630A	630A	4	2x185 mm ²
29300-1600	FMU 80/3	390x253x180	36515-0010	36703-0010	800A	800A	3	2x185 mm ²
29304-1600	FMU 80/4	475x253x180	36515-0010	36651-0010	800A	800A	4	2x185 mm ²

Changeover Switches /
 Load Break Switches / Switch-Fuses

Technical data

Type HSWA: 205 - 630 A / AC22B 415 V / AC23B 415V

Order No.	Type	Overall dimensions W x H x D	Order No. H1S10; aux contact 1NC 1NO in Pos. 1	Order No. DKLAD; incoming ter- minal shroud	Rated uninter- rupted current I _u	Rated oper. current I _e AC22B 415V	Rated oper. current I _e AC23B 415V	No. of Poles	Maximum conductor cross section
29160-1000	HSWA 25/3K	200x210x118	36516-0010	36538-0010	250A	250A	250A	3	185 mm ²
29164-1000	HSWA 25/4K	208x210x118	36516-0010	36538-0010	250A	on demand	on demand	4	185 mm ²
29160-1200	HSWA 30/3K	200x210x118	36516-0010	36538-0010	315A	315A	250A	3	195 mm ²
29164-1200	HSWA 30/4K	208x210x118	36516-0010	36538-0010	315A	on demand	on demand	4	195 mm ²
29160-1300	HSWA 40/3K	200x210x118	36516-0010	36538-0010	400A	400A	250A	3	240 mm ²
29164-1300	HSWA 40/4K	208x210x118	36516-0010	36538-0010	400A	on demand	on demand	4	240 mm ²
29160-1400	HSWA 50/3K	200x225x118	36516-0010	36538-0010	500A	500A	400A	3	2x150 mm ²
29164-1400	HSWA 50/4K	208x232x118	36516-0010	36538-0010	500A	on demand	on demand	4	2x150 mm ²
29160-1500	HSWA 63/3K	208x225x118	36516-0010	36538-0010	630A	630A	400A	3	2x185 mm ²
29164-1500	HSWA 63/4K	208x232x118	36516-0010	36538-0010	630A	on demand	on demand	4	2x185 mm ²

LU/LT

Changeover Switches /
 Load Break Switches / Switch-Fuses

Technical data

Type FMU BY1 (FMUN BY1): 63 - 800 A / AC21B 415V

Order No.	Type	Overall dimensions W x H x D	Order No. TKV- WV; door cou- pling, interlock, shaft extension	Order No. KLAD; overall terminal shroud	Rated uninter- rupted current I _u	Rated oper. current I _e AC21B 415V	No. of Poles	Maximum conductor cross section
29360-0400	FMU BY1-6/3	352x150x110	36540-0010	2x36503-0010	63A	63A	3	25 mm ²
29364-0400	FMU BY1-6/4	352x150x110	36540-0010	2x36503-0010	63A	63A	4	25 mm ²
29360-0500	FMU BY1-8/3	352x150x110	36540-0010	2x36503-0010	80A	80A	3	25 mm ²
29364-0500	FMU BY1-8/4	352x150x110	36540-0010	2x36503-0010	80A	80A	4	25 mm ²
29360-0600	FMU BY1-10/3	352x150x110	36540-0010	2x36503-0010	100A	100A	3	25 mm ²
29364-0600	FMU BY1-10/4	352x150x110	36540-0010	2x36503-0010	100A	100A	4	25 mm ²
29360-0700	FMU BY1-12/3	352x150x110	36540-0010	2x36503-0010	125A	125A	3	35 mm ²
29364-0700	FMU BY1-12/4	352x150x110	36540-0010	2x36503-0010	125A	125A	4	35 mm ²
29360-0800	FMU BY1-16/3	352x218x110	36540-0010	2x36503-0010	160A	160A	3	70 mm ²
29364-0800	FMU BY1-16/4	352x218x110	36540-0010	2x36503-0010	160A	160A	4	70 mm ²
29360-0900	FMUN BY1-20/3	474x181x110	36540-0010	2x36645-0010	200A	200A	3	120 mm ²
29364-0900	FMUN BY1-20/4	474x181x110	36540-0010	2x36645-0010	200A	200A	4	120 mm ²
29360-1000	FMUN BY1-25/3	474x181x110	36540-0010	2x36645-0010	250A	250A	3	150 mm ²
29364-1000	FMUN BY1-25/4	474x181x110	36540-0010	2x36645-0010	250A	250A	4	150 mm ²
29360-1100	FMUN BY1-30/3	570x285x159	36515-0010	2x36588-0010	300A	300A	3	185 mm ²
29364-1100	FMUN BY1-30/4	570x285x159	36515-0010	2x36588-0010	300A	300A	4	185 mm ²
29360-1300	FMUN BY1-40/3	570x285x159	36515-0010	2x36588-0010	400A	400A	3	240 mm ²
29364-1300	FMUN BY1-40/4	570x285x159	36515-0010	2x36588-0010	400A	400A	4	240 mm ²
29360-1400	FMUN BY1-50/3	570x285x159	36515-0010	2x36588-0010	500A	500A	3	300 mm ²
29364-1400	FMUN BY1-50/4	570x285x159	36515-0010	2x36588-0010	500A	500A	4	300 mm ²
29360-1500	FMU BY1-63/3	775x245x200	36515-0010	on demand	630A	on demand	3	2x185 mm ²
29364-1500	FMU BY1-63/4	945x245x200	36515-0010	2x36651-0010	630A	on demand	4	2x185 mm ²
29360-1600	FMU BY1-80/3	775x253x200	36515-0010	on demand	800A	on demand	3	2x185 mm ²
29364-1600	FMU BY1-80/4	945x253x200	36515-0010	2x36651-0010	800A	on demand	4	2x185 mm ²

Type FMU BY1: 1000 - 2000 A / AC21B 415V

Order No.	Type	Overall dimensions W x H x D	Order No. TKV- WV; door cou- pling, interlock, shaft extension	Order No. KLAD; overall terminal shroud	Rated uninter- rupted current I _u	Rated oper. current I _e AC21B 415V	No. of Poles	Maximum conductor cross section
29360-1700	FMU BY1-100/3	775x253x200	36515-0010	on demand	1000A	on demand	3	2x240 mm ²
29364-1700	FMU BY1-100/4	945x253x200	36515-0010	2x36651-0010	1000A	on demand	4	2x240 mm ²
29360-1800	FMU BY1-125/3	775x253x200	36515-0010	on demand	1250A	on demand	3	2x40x5 mm
29364-1800	FMU BY1-125/4	945x253x200	36515-0010	2x36651-0010	1250A	on demand	4	2x40x5 mm
29360-1900	FMU BY1-160/3	925x410x255	36612-0010	36694-0010	1600A	on demand	3	2x60x5 mm
29364-1900	FMU BY1-160/4	1125x410x255	36612-0010	36587-0010	1600A	on demand	4	2x60x5 mm
29360-2000	FMU BY1-200/3	925x410x255	36612-0010	36694-0010	2000A	on demand	3	2x80x5 mm
29364-2000	FMU BY1-200/4	1125x410x255	36612-0010	36587-0010	2000A	on demand	4	2x80x5 mm

One pole drawing for secure bypass function with ATN (automatical net commutate)

Technical data

One FMU Bypass switch and one FMU switch needed:

- short circuit secure switching in all positions
- high operational availability
- not complete potential free ATN bypassed for maintenance

This one pole drawing should be applied on 4 pole application.

Description:

- Normal ATN function is realised by Switch -S1 in ATN position
- ATN has still potential in Bypass state on outgoing*
- No short circuit could happen by any switching position
- For bypass function select at first bypass source with FMU -S2 then switch -S1 to bypass position

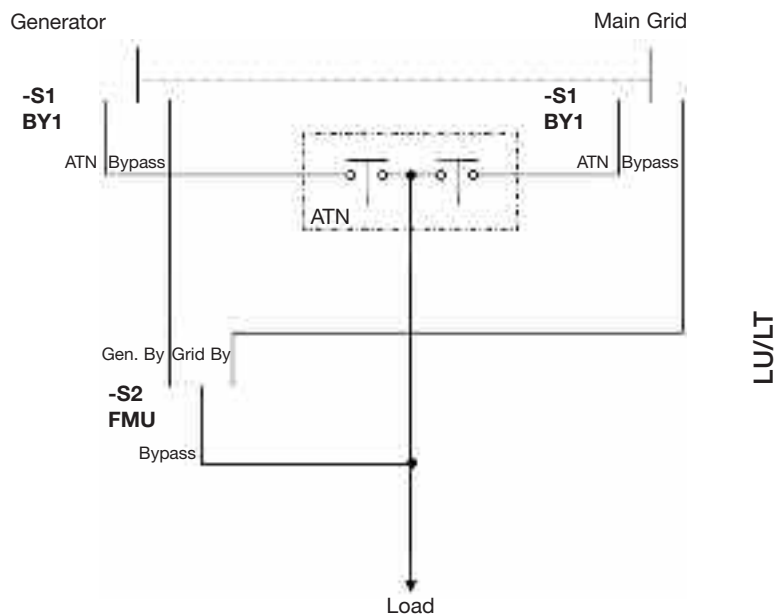

Standards

Norm	Type
EN 60947-1	FWA
EN 60947-3	FWA-HLD
IEC 60947-3	HSWA
VDE 0660-T107	FAM
	FMU (FMUN)
	FMU BY1 (FMUN BY1)
	SILA-NH
	SILAD-NH
EN 60947-1	SILA-BS
EN 60947-3	SILAD-BS
IEC 60947-3	
VDE 0660-T107	
BS 88	